



Rationelle Bearbeitung von langen und sperrigen Profilen

Efficient processing of long and bulky profiles

Usinage efficace de profils longs et encombrants

Lavorazione ottimale di profili lunghi ed ingombranti

? Challenge



Dachreling / Dachträger | Roof rack / roof rack
Barres de toit / Galeries de toit | Barre sul tetto / portapacchi

Rationelle und wirtschaftliche Mehrfachbearbeitung von langen und sperrigen Profilen.

Perform multiple machining operations on long and bulky profiles, economically and efficiently.

Usinage multiple et économique de profils longs et encombrants.

Lavorazione ottimale ed economica di profili lunghi ed ingombranti.

✓ Solutions



Stossstangen | Bumpers
Pare-chocs | Paraurti

Lösung

Ideal für solche Operationen und Werkstücke können Bearbeitungseinheiten eingesetzt werden. Sie sind universell einsetzbar und lassen sich überall entsprechend positionieren. Egal wie lange das Profil ist, egal wie viele Operationen getätigt werden müssen, alle Bearbeitungseinheiten arbeiten zeitgleich und nur die längste Bearbeitung definiert die totale Bearbeitungszeit. Geht es einmal eng zu, können die Einheiten mit Mehrspindel-Bohrköpfen adaptiert werden.

Solution

Machining units are ideal for such operations and work pieces. They are universal and can be positioned everywhere along side the work piece. No matter how long the profile, no matter how many operations have to be made, all machining units are working at the same time and only the longest operation defines the total cycle time. Machining units can be equipped with multiple spindle heads, capable to drill close center to center distances.

Solution

L'utilisation d'unités d'usinage est idéale pour de telles pièces et opérations. Elles sont universelles et peuvent être positionnées partout en conséquence. Peu importe la taille du profil, peu importe le nombre d'opérations devant être effectuées, toutes les unités d'usinage travaillent en même temps. Le temps de cycle menant est fonction de l'opération la plus longue et défini ainsi le temps de cycle total. En cas d'encombrement réduit, des têtes multibroches peuvent être adaptées aux unités d'usinage.

Soluzione

Le unità operatrici possono essere utilizzate per eseguire tutte le lavorazioni in modo ottimale. Esse lavorano in qualunque direzione, pertanto possono essere posizionate dove necessario. Non importa quanto lungo è il profilo, indipendentemente dal numero di operazioni che devono essere eseguite, tutte le unità di lavorazione operano contemporaneamente e solo la fase più lunga definisce il tempo ciclo totale. Inoltre, al fine di ridurre i tempi ciclo, le nostre unità possono essere dotate di teste di foratura a mandrini multipli.



Solarenergie | Solar energy
Énergie solaire | Energia solare

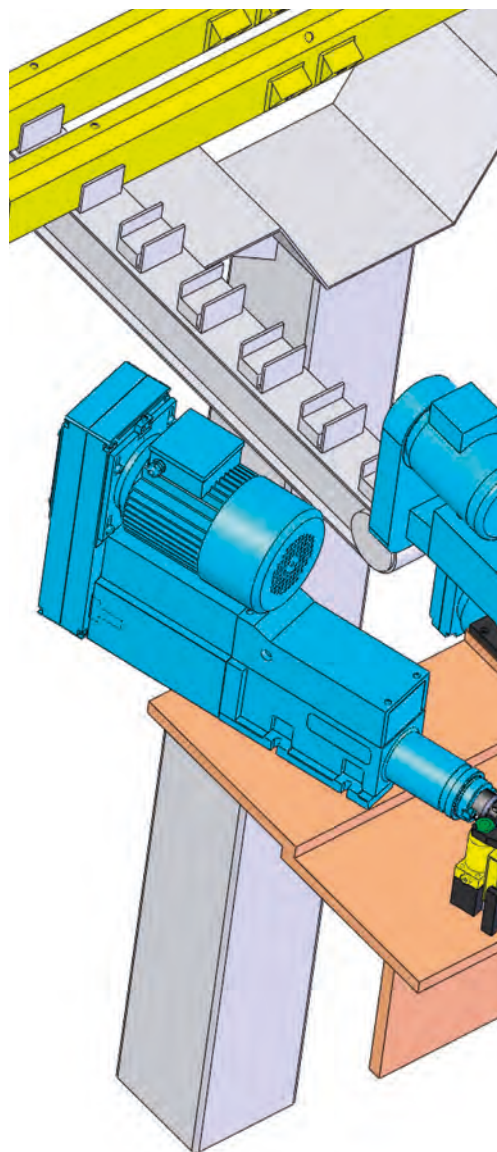

MACHINING

+ Advantages



LKW-Bordwände | Truck sideboards
Ridelles de camions | Pareti laterali di camion



Gerüstbau | Scaffolding
Échafaudages | Ponteggi



Lager- und Logistiksysteme | Storage and logistics systems
Systèmes de stockage et de logistique | Sistemi di logistica e magazzino

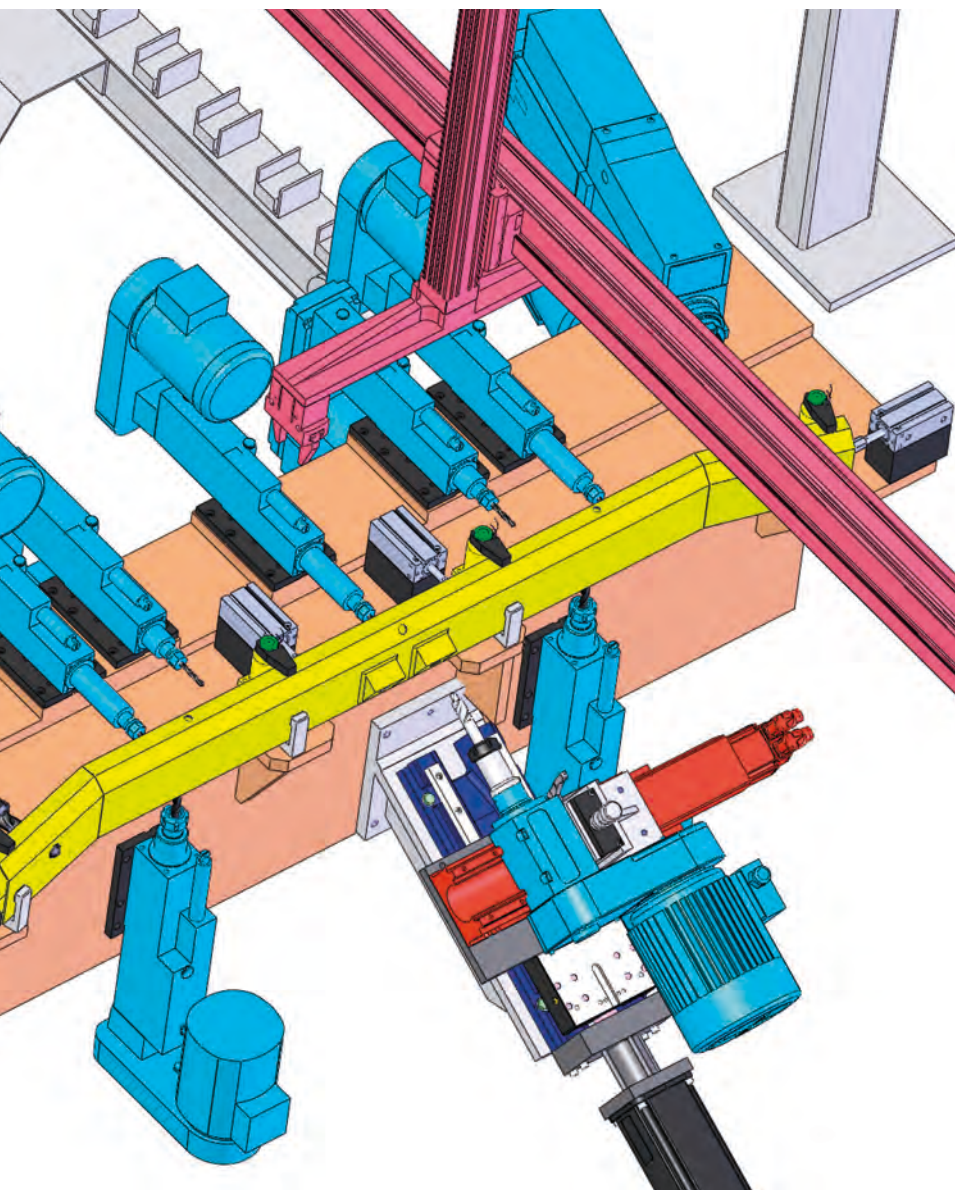

- Beliebig viele SUHNER-Bearbeitungseinheiten können gleichzeitig aus unterschiedlichen Richtungen alle Operationen erledigen.
- Je mehr Operationen, desto grösser die Zeiteinsparung!
- Kundenspezifische optimierte Lösungen dank lückenlosem modularem Baukastensystem.
- Robuste Bearbeitungseinheit für den harten Einsatz.
- Any number of SUHNER machining units can be applied from different directions and perform all necessary operations at the same time.
- The more operations, the greater the time savings!
- Standard and customized solutions through an optimized modular component system.
- Robust machining units for demanding applications.
- Toutes les unités d'usinage SUHNER peuvent travailler simultanément et depuis différentes directions.
- Plus il y a d'opérations, plus le gain de temps est important !
- Des solutions sur mesure optimisées par le système d'assemblage modulaire.
- Des unités d'usinage robustes pour une utilisation intensive
- Qualunque sia il numero di unità di lavorazione SUHNER, esse eseguono simultaneamente e da varie direzioni tutte le operazioni.
- Maggiori sono le operazioni da eseguire e maggiore è il risparmio di tempo!
- Soluzioni personalizzate per il cliente, grazie alla possibilità di assemblare le unità a seconda della necessità.
- Unità di lavorazione robuste anche per utilizzo impegnativo.

SUHNER®

EXPERTS. SINCE 1914.



ABRASIVE









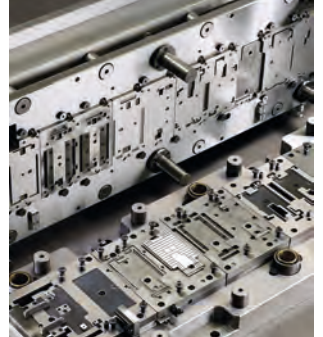







MACHINING



TRANSMISSION



STAMPING

					
	Switzerland	OTTO SUHNER AG	Lupfig	machining.ch@suhner.com	+41 (0)56 464 28 28
	Switzerland	SUHNER Automation AG	Lupfig	machining.sag@suhner.com	+41 (0)56 464 28 45
	Switzerland	SU-matic AG	Lupfig	machining.su-matic@suhner.com	+41 (0)56 464 29 90
	Germany	Otto Suhner GmbH	Bad Säckingen	machining.de@suhner.com	+49 (0)7761 557 0
	Austria	SUHNER SU-matic	Wien	machining.at@suhner.com	+43 (0)1 587 16 14
	USA	SUHNER Industrial Products Corp.	Rome, GA	machining.us@suhner.com	+1 (706) 235-8046
	France	Somex SAS	Ensisheim	machining.fr@suhner.com	+33 (0)3 89 81 12 12
	Italy	Suhner SU-matic S.r.l.	Zola Predosa	machining.it@suhner.com	+39 051 6 16 66 73
	Mexico	SUHNER Productos Industriales	San Juan del Rio	machining.mx@suhner.com	+52 427 272 39 78
	India	SUHNER India Pvt. Ltd.	Bangalore	machining.in@suhner.com	+91 (0) 80- 27 831108
	China	Suhner (Suzhou) Ind. Techn. Ltd.	Suzhou	machining.cn@suhner.com	+86 512 628 77 808

www.suhner.com